

## DATA SHEET HIS: **STRIP HOLDER** for ASECNA

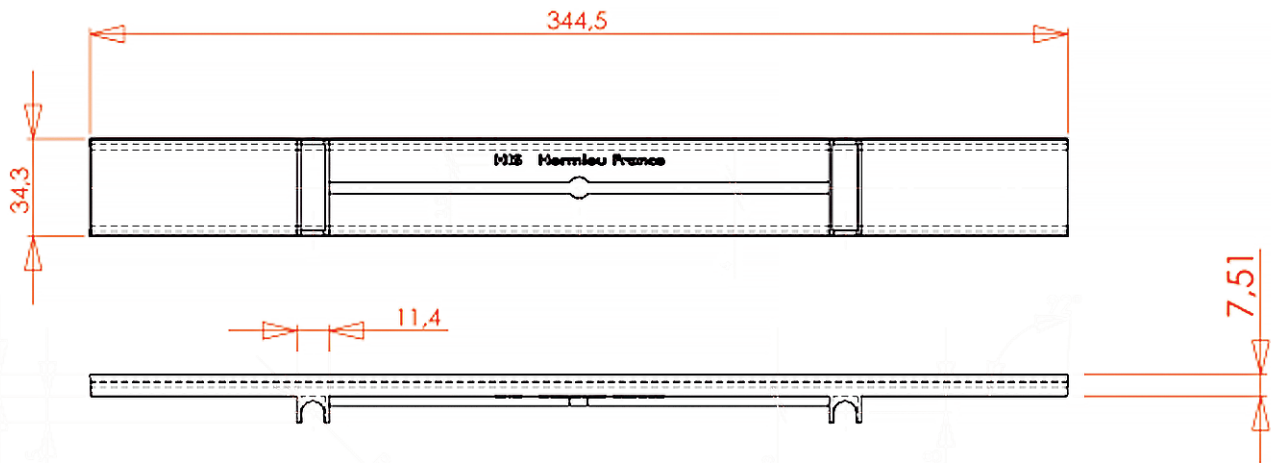











### **DIMENSION:**

Size 1 : 13"1/2 or 344.5 mm x 34.3mm  
Size 2 : 10" or 255mm x 34.3mm

### **TOOL EQUIPMENT:**

Central direct injection  
Steel footprints :  
1.2311 (30-34 HRC) et 1.2344 (48-52 HRC)  
Injection Strip-holder  
ABS Terluran GP22 Natural (BASF)

### **COLORS :**

 Blue	 Pink
 Yellow	 Red
 Green	 Buff
 Khaki	 Brown
 White	 Black

OR ANY OTHER  
COLORS ON REQUEST

